



Hunter[®]

240v/50Hz Selection Guide 2022
Includes a selection of dual cycle models

WHY HUNTER?

Hunter ceiling fans are designed to be as dependable as they are whisper quiet. We test, and test, and test each design a little too much. In fact, we perform more quality testing than any of our competitors. If you're interested in our testing process watch our video at www.hunterfan.com. You'll see how we test for weather conditions, vibrations and a lot more.

WOBBLE FREE
WHISPER QUIET
LONG LASTING









TABLE OF CONTENTS

MODERN.....7

TRADITIONAL.....26

OUTDOOR DAMP.....36

OUTDOOR WET.....45

OUTDOOR WEATHERMAX®49

ACCESSORIES.....53

ICON GUIDE

	Indoor	Rated for indoor spaces only
	Damp Rated	Damp rated for use as an indoor or outdoor ceiling fan in spaces exposed to moisture and humidity such as porches, patios, sunrooms, and bathrooms.
	Wet Rated	Wet rated for use in outdoor areas directly exposed to weather such as pergolas and also great indoors.
	Pull Chain	Includes pull chains for quick and easy on/off and speed adjustments.
	Wall Control	Includes wall control that lets you easily control the fan speed and function as well as the adjust dimmable light.
	Remote Control	Includes handheld remote control.
	Limited Lifetime Motor Warranty	Limited Lifetime Motor Warranty backed by the only company with over 135 years in the fan business
	Retail Box	Hunter branded packaging in full color.
	DC Motor	Ceiling fan with Direct Current motor.
	AC Motor	Ceiling fan with Alternating Current motor.
	Summer Winter	Ceiling fan with the ability to change the direction the fan blades spin. For summer, use counterclockwise direction. For Winter, use clockwise direction.
	Reversible Blades	Blades have two side options with same or different finishes.
	Low Profile Mounting	Low Profile housing specially designed to fit flush to the ceiling or for use in rooms with low ceilings.
	Flexible Mounting	Choose between a standard, low, or angled installation for a variety of ceiling heights and angles.
	50/60Hz	50/60Hz dual cycle





Modern

36" / 91cm Finley





50643

-  American Walnut
-  Natural Wood



50644

-  Fresh White
-  Natural Wood



AC Motor



WhisperWind[®] Motor



Indoor



Reversible Blades



Flexible Mounting



Remote Control



Summer Winter



Retail Box



Fan Dimensions in Centimeters

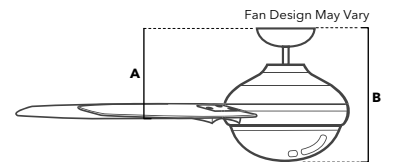

Profile	A	B
Low Profile	25.2	37.4
Standard	27.7	39.9
Angled	111.6	123.7

5.1cm and 10.2cm downrods included (1.9cm dia.)

SKU	Size	EAN 0049694	Housing Finish	Blades		Lighting Kit	Lightbulbs			Motor		Energy Information	
				Qty	Material		Qty	Base	Max. Watts	Type	Reversible	CFM High	Energy Use
50643	91cm / 36"	506436	Brushed Nickel / Níquel Cepillado	3	Composite / Compuesta	Yes / Si	2 LED	E27	Bulbs Not Included	AC	Yes / Si	3055	36W
50644		506443	Fresh White / Blanco Fresco										
SKU	Tamaño	EAN 0049694	Acabado	Cant.	Material	Juego de Iluminación	Cant.	Base	Watt Max.	Tipo	Reversible	Flujo de Aire	Uso Energético
				Aspas			Bombillas			Motor		Información Energética	

42" / 107cm Nova



50616



50617

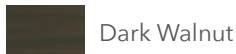

AC Motor



WhisperWind®
Motor



Indoor



Flexible
Mounting



Wall
Control



Summer
Winter



Retail Box



Fan Dimensions in Centimeters

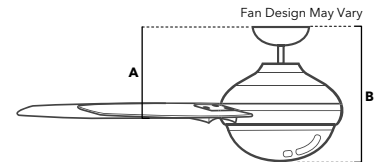

Standard
A. 21.8
B. 32.2

7.6cm downrod included (1.9cm dia.)

SKU	Size	EAN 0049694	Housing Finish	Blades		Lighting Kit	Lightbulbs			Motor		Energy Information	
				Qty	Material		Qty	Base	Max. Watts	Type	Reversible	CFM High	Energy Use
50616	107cm / 42"	506160	Architectural White / Blanco Arquitectónico	3	Plywood / Madera Contrachapada	Yes / Si	2 LED	E27	Bulbs Not Included	AC	Yes / Si	3730	80W
50617		506177	Matte Black / Negro Mate										
SKU	Tamaño	EAN 0049694	Acabado	Cant.	Material	Juego de Iluminación	Cant.	Base	Watt Max.	Tipo	Reversible	Flujo de Aire	Uso Energético
					Aspas					Motor			Información Energética

MODERN

48" / 122cm Galileo



50621

- Dark Walnut
- Dark Oak



AC Motor



WhisperWind[®] Motor



Indoor



Flexible Mounting



Reversible Blades



Wall Control



Summer Winter



Retail Box



Fan Dimensions in Centimeters

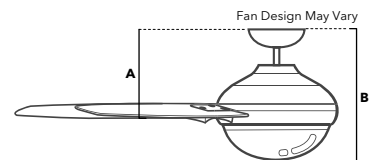

Standard
A. 23.1
B. 34.5

7.6cm downrod included (1.9cm dia.)

SKU	Size	EAN 0049694	Housing Finish	Blades		Lighting Kit	Lightbulbs			Motor		Energy Information	
				Qty	Material		Qty	Base	Max. Watts	Type	Reversible	CFM High	Energy Use
50621	122cm / 48"	506214	Brushed Nickel / Níquel Cepillado	3	Composite / Compuesta	Yes / Si	2 LED	E27	Bulbs Not Included	AC	Yes / Si	4379	80W
SKU	Tamaño	EAN 0049694	Acabado	Cant.	Material	Juego de Iluminación	Cant.	Base	Watt Max.	Tipo	Reversible	Flujo de Aire	Uso Energético
				Aspas				Bombillas		Motor		Información Energética	

48" / 122cm Kohala Bay



50610

 Matte Black



AC Motor



WhisperWind® Motor



Indoor



Flexible Mounting



Pull Chain



Summer Winter



Retail Box

Fan Dimensions in Centimeters

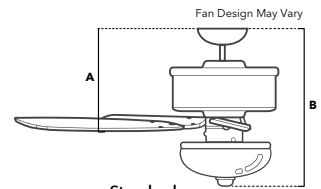

Standard
A. 30.5
B. 47.3

7.6cm downrod included (1.9cm dia.)

SKU	Size	EAN 0049694	Housing Finish	Blades		Lighting Kit	Lightbulbs			Motor		Energy Information	
				Qty	Material		Qty	Base	Max. Watts	Type	Reversible	CFM High	Energy Use
50610	122cm / 48"	506108	Antique Pewter / Peltre Antiguo	3	Wicker / Mimbres	Yes / Si	2 LED	E27	Bulbs Not Included	AC	Yes / Si	4520	80W
SKU	Tamaño	EAN 0049694	Acabado	Cant.	Material	Juego de Iluminación	Cant.	Base	Watt Max.	Tipo	Reversible	Flujo de Aire	Uso Energético
				Aspas			Bombillas			Motor		Información Energética	

MODERN

52"/ 132cm Flight



50630



Coffee Beech



AC Motor



WhisperWind[®]
Motor



Indoor



Flexible
Mounting



Wall
Control



Summer
Winter



Retail Box



Fan Dimensions in Centimeters

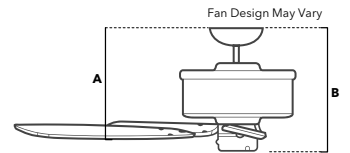

Standard
A. 28.9
B. 24.6

7.6cm downrod included (1.9cm dia.)

SKU	Size	EAN 0049694	Housing Finish	Blades		Lighting Kit	Lightbulbs			Motor		Energy Information	
				Qty	Material		Qty	Base	Max. Watts	Type	Reversible	CFM High	Energy Use
50630	132cm / 52"	506306	Brushed Nickel / Níquel Cepillado	3	Plastic / Plástico	No	N/A	N/A	N/A	AC	No	5208	100W
SKU	Tamaño	EAN 0049694	Acabado	Cant.	Material	Juego de Iluminación	Cant.	Base	Watt Max.	Tipo	Reversible	Flujo de Aire	Uso Energético
					Aspas					Motor			Información Energética

52"/ 132cm Industrie II



24542

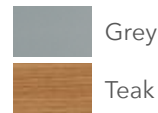

24545

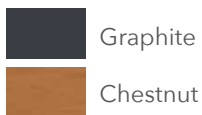

24547

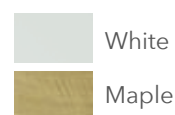

AC Motor



Indoor



Flexible Mounting



Reversible Blades



Wall Control



Summer Winter



Retail Box

Fan Dimensions in Centimeters

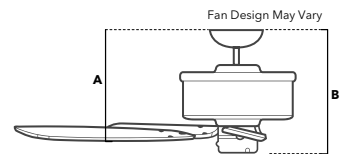

Standard
A. 36.7
B. 32.2

7.6cm downrod included (1.9cm dia.)



SKU	Size	EAN 0049694	Housing Finish	Blades		Lighting Kit	Lightbulbs			Motor		Energy Information	
				Qty	Material		Qty	Base	Max. Watts	Type	Reversible	CFM High	Energy Use
24542	132cm / 52"	245427	Brushed Chrome / Cromo Cepillado	3	Plywood / Madera Contrachapada	No	N/A	N/A	N/A	AC	No	5240	100W
24545		245458	Graphite / Grafito										
24547		245472	White / Blanco										
SKU	Tamaño	EAN 0049694	Acabado	Cant.	Material	Juego de Iluminación	Cant.	Base	Watt Max.	Tipo	Reversible	Flujo de Aire	Uso Energético
				Aspas		Bombillas		Motor		Información Energética			

52"/ 132cm Carera



24241

- Chestnut
- Graphite



24246

- Snow White
- Maple



AC Motor



Reversible
Blades



Indoor



Pull Chain



Flexible
Mounting



Summer
Winter



Retail Box

Fan Dimensions in Centimeters

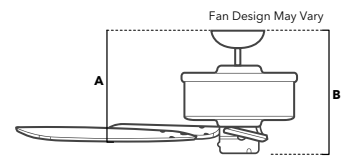

Standard
A. 34.9
B. 25.5

7.6cm downrod included (1.9cm dia.)



SKU	Size	EAN 0049694	Housing Finish	Blades		Lighting Kit	Lightbulbs			Motor		Energy Information	
				Qty	Material		Qty	Base	Max. Watts	Type	Reversible	CFM High	Energy Use
24241	132cm / 52"	242419	Graphite / Grafito	3	Plywood / Madera Contrachapada	No	N/A	N/A	N/A	AC	No	5673	100W
24246		242464	Architectural White / Blanco Arquitectónico										
SKU	Tamaño	EAN 0049694	Acabado	Cant.	Material	Juego de Iluminación	Cant.	Base	Watt Max.	Tipo	Reversible	Flujo de Aire	Uso Energético
					Aspas					Motor		Información Energética	

54" / 137cm Harmony



50625

Matte Nickel



50626

Fresh White



50964

Light Grey Oak



AC Motor



WhisperWind® Motor



Indoor



Flexible Mounting



Remote Control



Summer Winter



Retail Box



50/60 Hz Dual Cycle

Fan Dimensions in Centimeters

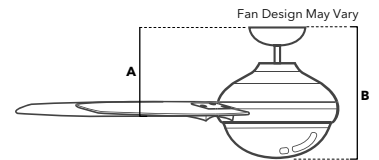

Low Profile

A. 22.6
B. 29.4

Standard

A. 29.9
B. 37.2

Angled

A. 113.8
B. 120.98

5.1cm downrod included (1.9cm dia.)



SKU	Size	EAN 0049694	Housing Finish	Blades		Lighting Kit	Lightbulbs			Motor		Energy Information	
				Qty	Material		Qty	Base	Max. Watts	Type	Reversible	CFM High	Energy Use
50625	137cm / 54"	506252	Matte Nickel / Níquel Mate	3	Plastic / Plástico	Yes / Si	2 LED	E27	Bulbs Not Included	AC	Yes / Si	5884	56W
50626		506269	Fresh White / Blanco Fresco										
50964		509642	Noble Bronze / Bronce Noble										
SKU	Tamaño	EAN 0049694	Acabado	Cant.	Material	Juego de Iluminación	Cant.	Base	Watt Max.	Tipo	Reversible	Flujo de Aire	Uso Energético
				Aspas			Bombillas			Motor		Información Energética	

MODERN

42" / 107cm Beck



50655

-  Light Gray Oak
-  Warm Grey Oak



AC Motor



WhisperWind® Motor



Reversible Blades



Indoor



Flexible Mounting



Remote Control



Summer Winter



Retail Box

Fan Dimensions in Centimeters

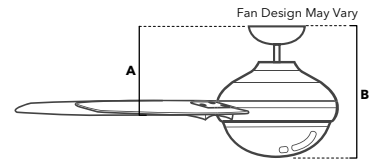

Flush
A. 22.1
B. 33.7

Standard
A. 27.2
B. 38.8

Angled
A. 113.5
B. 125.1

5.1cm and 10.2cm downrod included (1.9cm dia.)



SKU	Size	EAN 0049694	Housing Finish	Blades		Lighting Kit	Lightbulbs			Motor		Energy Information		
				Qty	Material		Qty	Base	Max. Watts	Type	Reversible	CFM High	Energy Use	
50655	107cm / 42"	506559	Brushed Nickel / Níquel Cepillado	4	Composite / Compuesto	Yes / Si	2 LED	E27	Bulbs Not Included	AC	Yes / Si	3660	43W	
SKU	Tamaño	EAN 0049694	Acabado	Cant.	Material	Juego de Iluminación	Cant.	Base	Watt Max.	Tipo	Reversible	Flujo de Aire	Uso Energético	
				Aspas				Bombillas			Motor		Información Energética	

42"/ 107cm Central Park



50618

- Dark Walnut
- Grey Walnut



50619

- Black Oak Grain
- Dark Walnut



AC Motor



Reversible
Blades



Indoor



Flexible
Mounting

Fan Dimensions in Centimeters

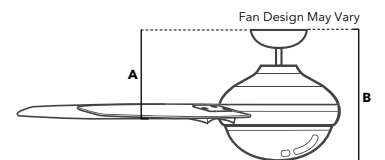

Standard
A. 23.3
B. 35.6

7.6cm downrod included (1.9cm dia.)



Wall
Control



Summer
Winter





Retail Box

SKU	Size	EAN 0049694	Housing Finish	Blades		Lighting Kit	Lightbulbs			Motor		Energy Information	
				Qty	Material		Qty	Base	Max. Watts	Type	Reversible	CFM High	Energy Use
50618	107cm / 42"	506184	Aged Steel / Hierro Antiguo	4	MDF	Yes / Si	2 LED	Std.	Bulbs Not Included	AC	Yes / Si	3603	80W
50619		506191	Pewter Revival/ Peltre Renovado										
SKU	Tamaño	EAN 0049694	Acabado	Cant.	Material	Juego de Iluminación	Cant.	Base	Watt Max.	Tipo	Reversible	Flujo de Aire	Uso Energético
					Aspas					Motor		Información Energética	

44" / 112cm Dante





50628

-  Black Oak
-  Chocolate Oak Grain



50629

-  Blonde Oak
-  Fresh White



AC Motor



Reversible
Blades



Indoor



Remote
Control



Flexible
Mounting



Summer
Winter



Retail Box

Fan Dimensions in Centimeters

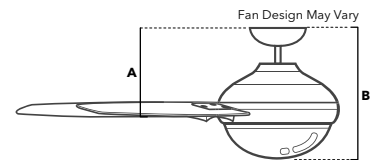

Standard
A. 23.3
B. 34.3

6.4cm downrod included (1.9cm dia.)





SKU	Size	EAN 0049694	Housing Finish	Blades		Lighting Kit	Lightbulbs			Motor		Energy Information	
				Qty	Material		Qty	Base	Max. Watts	Type	Reversible	CFM High	Energy Use
50628	112cm / 44"	506283	Brushed Nickel / Níquel Cepillado	4	MDF	Yes / Si	2 LED	E27	Bulbs Not Included	AC	Yes	4523	40W
50629		506290	Fresh White / Blanco Fresco										
SKU	Tamaño	EAN 0049694	Acabado	Cant.	Material	Juego de Iluminación	Cant.	Base	Watt Max.	Tipo	Reversible	Flujo de Aire	Uso Energético
				Aspas		Bombillas		Motor		Información Energética			

50" / 127cm Mercado



50650

-  Light Grey Oak
-  Aged Oak



AC Motor



WhisperWind® Motor



Reversible Blades



Indoor



Flexible Mounting



Remote Control



Summer Winter



Retail Box



Fan Dimensions in Centimeters

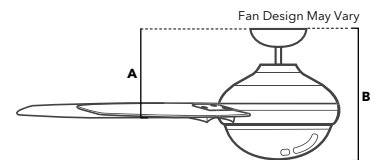

Flush
A. 23.1
B. 34.3

Standard
A. 28.2
B. 39.4

Standard
A. 114.6
B. 125.7

5.1cm and 10.2cm downrods included (1.9cm dia.)

SKU	Size	EAN 0049694	Housing Finish	Blades		Lighting Kit	Lightbulbs			Motor		Energy Information	
				Qty	Material		Qty	Base	Max. Watts	Type	Reversible	CFM High	Energy Use
50650	127cm / 50"	506504	Brushed Nickel / Níquel Cepillado	4	Composite / Compuesto	Yes / Si	2 LED	E27	Bulbs Not Included	AC	Yes / Si	5032	45W
SKU	Tamaño	EAN 0049694	Acabado	Cant.	Material	Juego de Iluminación	Cant.	Base	Watt Max.	Tipo	Reversible	Flujo de Aire	Uso Energético
					Aspas					Motor		Información Energética	

MODERN

52"/ 132cm Sonic



50665



50666



AC Motor



WhisperWind[®] Motor



Indoor



Flexible Mounting



Remote Control



Summer Winter



Retail Box

Fan Dimensions in Centimeters

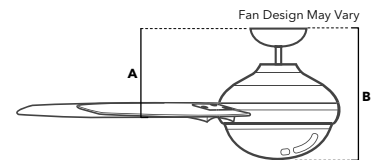

Standard
A. 25.9
B. 36.7



10.2cm downrods included (1.9cm dia.)

SKU	Size	EAN 0049694	Housing Finish	Blades		Lighting Kit	Lightbulbs			Motor		Energy Information	
				Qty	Material		Qty	Base	Max. Watts	Type	Reversible	CFM High	Energy Use
50665	132cm / 52"	506658	White / Blanco	4	Composite / Compuesto	Yes / Si	2 LED	E27	Bulbs Not Included	AC	Yes / Si	5709	100W
50666		506665	Brushed Nickel / Niquel Cepillado										
SKU	Tamaño	EAN 0049694	Acabado	Cant.	Material	Juego de Iluminación	Cant.	Base	Watt Max.	Tipo	Reversible	Flujo de Aire	Uso Energético
					Aspas					Motor			Información Energética

52"/ 132cm Loki





50424

-  Light Grey Oak
-  Natural Wood



50423

-  Fresh White
-  Bleached Oak



50425

-  Light Grey Oak
-  Matte Black



AC Motor



WhisperWind[®] Motor



Reversible Blades



Indoor



Flexible Mounting



Remote Control



Summer Winter



Retail Box



Fan Dimensions in Centimeters

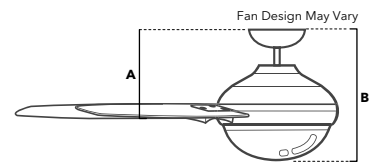

Flush	Standard	Standard
A. 24.2	A. 29.3	A. 115.7
B. 37.7	B. 42.8	B. 129.1



5.1cm and 10.2cm downrods included (1.9cm dia.)

SKU	Size	EAN 0049694	Housing Finish	Blades		Lighting Kit	Lightbulbs			Motor		Energy Information	
				Qty	Material		Qty	Base	Max. Watts	Type	Reversible	CFM High	Energy Use
50424	132cm / 52"	504241	Brushed Nickel / Níquel Cepillado	4	Composite / Compuesto	Yes / Si	2 LED	E27	Bulbs Not Included	AC	Yes / Si	5290	45W
50425		504254	Matte Black / Negro Mate										
50423		504238	Fresh White / Blanco Fresco										
SKU	Tamaño	EAN 0049694	Acabado	Cant.	Material	Juego de Iluminación	Cant.	Base	Watt Max.	Tipo	Reversible	Flujo de Aire	Uso Energético
				Aspas		Bombillas		Motor		Información Energética			

46" / 117cm Stile





50640

-  Light Grey Oak
-  Grey Walnut



50641

-  Dark Walnut
-  American Walnut



AC Motor



WhisperWind[®] Motor



Reversible Blades



Indoor



Flexible Mounting



Remote Control



Summer Winter



Retail Box

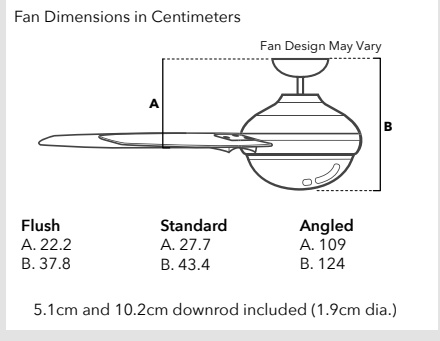



SKU	Size	EAN 0049694	Housing Finish	Blades		Lighting Kit	Lightbulbs			Motor		Energy Information	
				Qty	Material		Qty	Base	Max. Watts	Type	Reversible	CFM High	Energy Use
50640	117cm / 46"	506405	Matte Silver / Plata Mate	5	Composite / Compuesta	Yes / Si	2 LED	E27	Bulbs Not Included	AC	Yes / Si	4374	38W
50641		506412	Premier Bronze / Bronce Premier										
SKU	Tamaño	EAN 0049694	Acabado	Cant.	Material	Juego de Iluminación	Cant.	Base	Watt Max.	Tipo	Reversible	Flujo de Aire	Uso Energético
				Aspas		Bombillas				Motor		Información Energética	

46" / 117cm Arcot





50646

-  Light Grey Oak
-  Grey Walnut



50647

-  Fresh White
-  Bleached Grey Pine



AC Motor



WhisperWind[®] Motor



Reversible Blades



Indoor



Flexible Mounting



Pull Chain



Summer Winter



Retail Box



Fan Dimensions in Centimeters

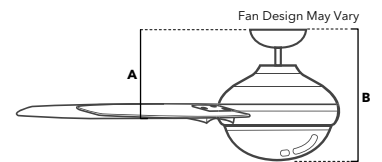

Standard
A. 28
B. 39.8



10.2cm and 5.1cm downrods included (1.9cm dia.)

SKU	Size	EAN 0049694	Housing Finish	Blades		Lighting Kit	Lightbulbs			Motor		Energy Information	
				Qty	Material		Qty	Base	Max. Watts	Type	Reversible	CFM High	Energy Use
50646	117cm / 46"	506467	Brushed Nickel / Níquel Cepillado	5	Composite / Compuesta	Yes / Si	2 LED	E27	Bulbs Not Included	AC	Yes / Si	4132	42W
50647		506474	Fresh White / Blanco Fresco										
SKU	Tamaño	EAN 0049694	Acabado	Cant.	Material	Juego de Iluminación	Cant.	Base	Watt Max.	Tipo	Reversible	Flujo de Aire	Uso Energético
				Aspas				Bombillas		Motor		Información Energética	

52" / 132cm Claudette



50652

-  Light Grey Oak
-  Drifted Oak



AC Motor



WhisperWind[®] Motor



Reversible Blades



Indoor



Flexible Mounting



Remote Control



Summer Winter



Retail Box



Fan Dimensions in Centimeters

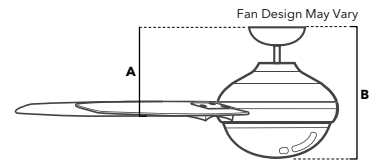

Flush	Standard	Angled
A. 17.7 B. 29.7	A. 22.7 B. 34.7	A. 109.1 B. 121.1

5.1cm and 10.2cm downrods included (1.9cm dia.)

SKU	Size	EAN 0049694	Housing Finish	Blades		Lighting Kit	Lightbulbs			Motor		Energy Information	
				Qty	Material		Qty	Base	Max. Watts	Type	Reversible	CFM High	Energy Use
50652	132cm / 52"	506528	Polished Nickel / Níquel Pulido	5	Composite / Compuesto	Yes / Si	2 LED	E27	Bulbs Not Included	AC	Yes / Si	3947	44W
SKU	Tamaño	EAN 0049694	Acabado	Cant.	Material	Juego de Iluminación	Cant.	Base	Watt Max.	Tipo	Reversible	Flujo de Aire	Uso Energético
					Aspas				Bombillas		Motor		Información Energética

52"/ 132cm Contempo



50612

- Dark Walnut
- English Cherry



50613

- Snow White
- Light Oak



AC Motor



WhisperWind[®] Motor



Reversible Blades



Indoor



Flexible Mounting



Remote Control



Summer Winter



Retail Box

Fan Dimensions in Centimeters

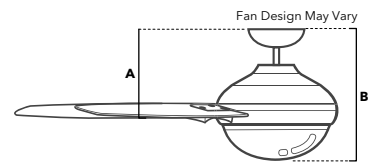

Standard
A. 25.6
B. 36.1

7.6cm downrod included (1.9cm dia.)



SKU	Size	EAN 0049694	Housing Finish	Blades		Lighting Kit	Lightbulbs			Motor		Energy Information	
				Qty	Material		Qty	Base	Max. Watts	Type	Reversible	CFM High	Energy Use
50612	132cm / 52"	506122	Brushed Nickel / Niquel Cepillado	5	Composite / Compuesto	Yes / Si	2	E27	Bulbs Not Included	AC	Yes / Si	3892	42W
50613		506139	White / Blanco										
SKU	Tamaño	EAN 0049694	Acabado	Cant.	Material	Juego de Iluminación	Cant.	Base	Watt Max.	Tipo	Reversible	Flujo de Aire	Uso Energético
					Aspas					Motor			Información Energética





Traditional

42"/ 107cm Bayport





24170

-  White
-  Light Oak





24174

-  Rosewood
-  Medium Oak



24179

-  Maple
-  Cherry



AC Motor



Reversible
Blades



Indoor



Pull Chain



Summer
Winter



Retail Box

Fan Dimensions in Centimeters

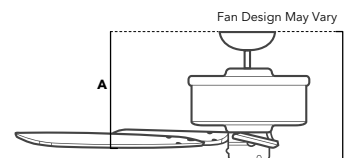

Standard
A. 29.1
B. 32.7

7.6cm downrod included (1.9cm dia.)





SKU	Size	EAN 0049694	Housing Finish	Blades		Lighting Kit	Lightbulbs			Motor		Energy Information	
				Qty	Material		Qty	Base	Max. Watts	Type	Reversible	CFM High	Energy Use
24170	107cm / 42"	241702	White / Blanco	4	MDF	No	N/A	N/A	N/A	AC	No	4137	80W
24174		241740	Antique Brass / Latón Antiguo										
24179		241795	Brushed Nickel / Níquel Cepillado										
SKU	Tamaño	EAN 0049694	Acabado	Cant.	Material	Juego de Iluminación	Cant.	Base	Watt Max.	Tipo	Reversible	Flujo de Aire	Uso Energético
					Aspas					Motor			Información Energética

42" / 107cm Beacon Hill





24902

-  Cherry
-  Maple





24904

-  Rosewood
-  Medium Oak



24905

-  White
-  Light Oak



AC Motor



WhisperWind® Motor



Reversible Blades



Indoor



50/60 Hz Dual Cycle

Fan Dimensions in Centimeters

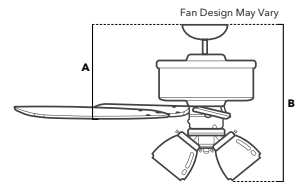

Standard
A. 27.5
B. 45.6

7.6cm downrod included (1.9cm dia.)



Flexible Mounting



Pull Chain



Summer Winter





Retail Box

SKU	Size	EAN 0049694	Housing Finish	Blades		Lighting Kit	Lightbulbs			Motor		Energy Information	
				Qty	Material		Qty	Base	Max. Watts	Type	Reversible	CFM High	Energy Use
24902	107cm / 42"	249029	Brushed Nickel / Níquel Cepillado	5	MDF	Yes / Si	3 LED	E27	Bulbs Not Included	AC	Yes / Si	2913	34W
24904		242043	Antique Brass / Latón Antiguo										
24905		249050	White / Blanco										
SKU	Tamaño	EAN 0049694	Acabado	Cant.	Material	Juego de Iluminación	Cant.	Base	Watt Max.	Tipo	Reversible	Flujo de Aire	Uso Energético
					Aspas					Motor		Información Energética	

44"/ 112cm Seville II





24034

-  Walnut
-  Medium Oak





24037

-  White
-  Light Oak





24038

-  Maple
-  Grey



24039

-  Dark Cherry
-  Medium Oak



AC Motor



Reversible
Blades



Indoor



Flexible
Mounting



Pull Chain



Summer
Winter



Retail Box



Fan Dimensions in Centimeters

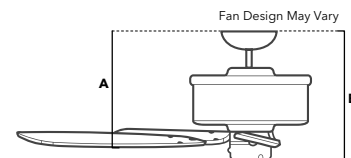

Standard
A. 34.5
B. 31.0

7.6cm downrod included (1.9cm dia.)

SKU	Size	EAN 0049694	Housing Finish	Blades		Lighting Kit	Lightbulbs			Motor		Energy Information	
				Qty	Material		Qty	Base	Max. Watts	Type	Reversible	CFM High	Energy Use
24034	112cm / 44"	240347	Antique Brass / Latón Antiguo	5	Plywood / Madera Contrachapada	No	N/A	N/A	N/A	AC	No	4574	100W
24037		240378	Snow White / Blanco Nieve										
24038		240385	Brushed Nickel / Níquel Cepillado										
24039		240392	New Bronze / Bronce Nuevo										
SKU	Tamaño	EAN 0049694	Acabado	Cant.	Material	Juego de Iluminación	Cant.	Base	Watt Max.	Tipo	Reversible	Flujo de Aire	Uso Energético
				Aspas				Bombillas		Motor		Información Energética	



TRADITIONAL

44" / 112cm Low Profile III

52" / 132cm





24372

-  Chocolate
-  Maple



24377

-  White
-  Maple



AC Motor



WhisperWind[®] Motor



Reversible Blades



Indoor



Low Profile Mounting



Pull Chain



Summer Winter



Retail Box

Fan Dimensions in Centimeters

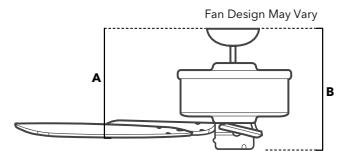

Low Profile
A. 21.2
B. 24.6

2 Sets of blades (132cm and 112cm) included





SKU	Size	EAN 0049694	Housing Finish	Blades		Lighting Kit	Lightbulbs			Motor		Energy Information	
				Qty	Material		Qty	Base	Max. Watts	Type	Reversible	CFM High	Energy Use
24372	112cm / 44"	243720	Brushed Nickel / Níquel Cepillado	5	Plywood / Madera Contrachapada	No	N/A	N/A	N/A	AC	No	4414	43W
24377	132cm / 52"	243775	White / Blanco										
SKU	Tamaño	EAN 0049694	Acabado	Cant.	Material	Juego de Iluminación	Cant.	Base	Watt Max.	Tipo	Reversible	Flujo de Aire	Uso Energético
					Aspas						Motor		Información Energética

52"/ 132cm Builder Elite



50566

-  Brazilian Cherry
-  Maple





50565

-  Snow White



50567

-  Brazilian Cherry
-  Yellow Walnut



AC Motor



WhisperWind[®] Motor



Reversible Blades



Indoor



Flexible Mounting



Pull Chain



Summer Winter



Retail Box

Fan Dimensions in Centimeters

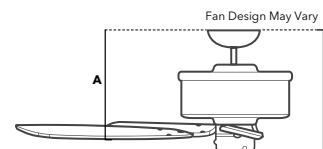

Low Profile
A. 25.2
B. 28.6

Standard
A. 27.9
B. 31.2

Angled
A. 111.6
B. 114.9

7.6cm downrod included (1.9cm dia.)





SKU	Size	EAN 0049694	Housing Finish	Blades		Lighting Kit	Lightbulbs			Motor		Energy Information	
				Qty	Material		Qty	Base	Max. Watts	Type	Reversible	CFM High	Energy Use
50565	132cm / 52"	505651	Snow White / Blanco Nieve	5	Composite / Compuesto	No	N/A	N/A	N/A	AC	Yes / Si	4844	80W
50566		505668	Brushed Nickel / Níquel Cepillado										
50567		505675	New Bronze / Bronce Nuevo										
SKU	Tamaño	EAN 0049694	Acabado	Cant.	Material	Juego de Iluminación	Cant.	Base	Watt Max.	Tipo	Reversible	Flujo de Aire	Uso Energético
				Aspas		Focos		Motor		Información Energética			

52"/ 132cm Builder Deluxe





50571

-  Brazilian Cherry
-  Smoked Walnut



50572

-  Brazilian Cherry
-  Yellow Walnut



50570

-  Snow White



AC Motor



WhisperWind[®] Motor



Reversible Blades



Indoor



Flexible Mounting



Pull Chain



Summer Winter



Retail Box



Fan Dimensions in Centimeters

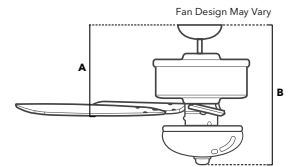

Low Profile
A. 25.2
B. 42.6

Standard
A. 27.7
B. 45.1

Angled
A. 111.6
B. 128.9



7.6cm downrod included (1.9cm dia.)

SKU	Size	EAN 0049694	Housing Finish	Blades		Lighting Kit	Lightbulbs			Motor		Energy Information		
				Qty	Material		Qty	Base	Max. Watts	Type	Reversible	CFM High	Energy Use	
50571	132cm / 52"	530905	Brushed Nickel / Níquel Cepillado	5	Composite / Compuesto	Yes / Si	2 LED	E27	Bulbs Not Included	AC	Yes / Si	5295	80W	
50572		505729	New Bronze / Bronce Nuevo											
50570		505705	Snow White / Blanco Nieve											
SKU	Tamaño	EAN 0049694	Acabado	Cant.	Material	Juego de Iluminación	Cant.	Base	Watt Max.	Tipo	Reversible	Flujo de Aire	Uso Energético	
				Aspas				Focos			Motor		Información Energética	

52"/ 132cm Builder Plus



50561

-  Brazilian Cherry
-  Burnt Walnut





50560

-  Snow White



50562

-  Brazilian Cherry
-  Yellow Walnut



AC Motor



WhisperWind® Motor



Reversible Blades



Indoor



Flexible Mounting



Pull Chain



Summer Winter



Retail Box

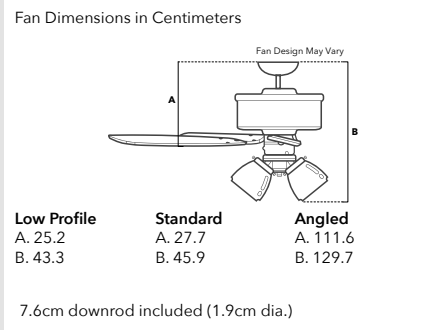



SKU	Size	EAN 0049694	Housing Finish	Blades		Lighting Kit	Lightbulbs			Motor		Energy Information	
				Qty	Material		Qty	Base	Max. Watts	Type	Reversible	CFM High	Energy Use
50560	132cm / 52"	505606	Snow White / Blanco Nieve	5	Composite / Compuesto	Yes / Si	3 LED	E27	Bulbs Not Included	AC	Yes / Si	5295	80W
50561		505613	Brushed Nickel / Níquel Cepillado										
50562		505620	New Bronze / Bronce Nuevo										
SKU	Tamaño	EAN 0049694	Acabado	Cant.	Material	Juego de Iluminación	Cant.	Base	Watt Max.	Tipo	Reversible	Flujo de Aire	Uso Energético
				Aspas		Focos			Motor		Información Energética		

52" / 132cm Savoy





24520

-  Rosewood
-  Medium Oak





24521

-  Maple
-  Cherry





24524

-  Rosewood
-  Medium Oak





24525

-  Distressed Cherry
-  Mahogany



24526

-  White
-  Light Oak



AC Motor



Reversible
Blades



Indoor



Flexible
Mounting



Pull Chain



Summer
Winter



Retail Box



Fan Dimensions in Centimeters

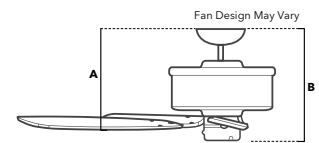

Standard
A. 32
B. 36.5

7.6cm downrod included (1.9cm dia.)

SKU	Size	EAN 0049694	Housing Finish	Blades		Lighting Kit	Lightbulbs			Motor		Energy Information	
				Qty	Material		Qty	Base	Max. Watts	Type	Reversible	CFM High	Energy Use
24520	132cm / 52"	245205	Antique Brass / Latón Antiguo	5	Plywood / Madera Contrachapada	No	N/A	N/A	N/A	AC	No	5089	100W
24521		245212	Brushed Nickel / Níquel Cepillado										
24524		245243	Bright Brass / Latón Brillante										
24525		245250	Amber Bronze / Bronce Ambar										
24526		245267	White / Blanco										
SKU	Tamaño	EAN 0049694	Acabado	Cant.	Material	Juego de Iluminación	Cant.	Base	Watt Max.	Tipo	Reversible	Flujo de Aire	Uso Energético
				Aspas		Bombillas		Motor		Información Energética			

54" / 137cm Caribbean Breeze



24457



Antique Dark Wicker



AC Motor



Indoor



Flexible Mounting



Pull Chain



Summer Winter



Retail Box

Fan Dimensions in Centimeters

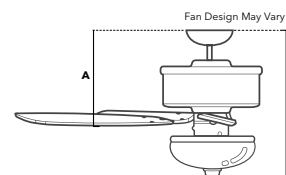

Low Profile
A. 28.5
B. 46.0

Standard
A. 36.4
B. 58.9

Angled
A. 115
B. 132

7.6cm downrod included (1.9cm dia.)



SKU	Size	EAN 0049694	Housing Finish
24457	137cm / 54"	244574	Weathered Bronze / Bronce Destagado
SKU	Tamaño	EAN 0049694	Acabado

Blades	
Qty	Material
5	Wicker / Mimbres
Cant.	Material
Aspas	

Lighting Kit	Lightbulbs		
	Qty	Base	Max. Watts
Yes / Si	1 LED	E27	Bulbs Not Included
Juego de Iluminación	Cant.	Base	Watt Max.
Bombillas			

Motor	
Type	Reversible
AC	No
Tipo	Reversible
Motor	

Energy Information	
CFM High	Energy Use
5092	80.5W
Flujo de Aire	Uso Energético
Información Energética	



Damp

52"/ 132cm Protos



50622

- Matte Silver
- Black Willow



50623

- Fresh White
- Light Stripe



50624

- Matte Black
- Grey Walnut Stripe



51220

- Premier Bronze
- Fire Polished Wood



AC Motor



WhisperWind® Motor



Flexible Mounting



Damp Rated



Reversible Blades



Wall Control



Summer Winter



Retail Box

Fan Dimensions in Centimeters

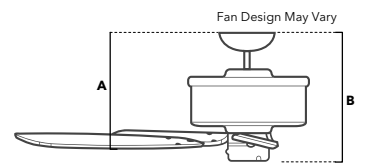

Low Profile	Standard	Angled
A. 22.1	A. 27.2	A. 105.9
B. 27.6	B. 32.6	B. 111.4

5.1cm and 12.7cm downrod included (1.9cm dia.)

SKU	Size	EAN 0049694	Housing Finish	Blades		Lighting Kit	Lightbulbs			Motor		Energy Information	
				Qty	Material		Qty	Base	Max. Watts	Type	Reversible	CFM High	Energy Use
50622	132cm / 52"	506221	Matte Silver / Plata Mate	3	Plywood / Madera Contrachapada	No	N/A	N/A	N/A	AC	Yes / Si	4542	41W
50623		506238	Fresh White / Blanco Fresco										
50624		506245	Matte Black / Negro Mate										
51220		512208	Premier Bronze / Bronce Premier										
SKU	Tamaño	EAN 0049694	Acabado	Cant.	Material	Juego de Iluminación	Cant.	Base	Watt Max.	Tipo	Reversible	Flujo de Aire	Uso Energético
				Aspas			Focos			Motor		Información Energética	

52"/ 132cm Cabo Frio



50638

 Matte Black



50634

 Fresh White



50635

 Coffee Beech



AC Motor



WhisperWind[®] Motor



Damp Rated



Flexible Mounting



Wall Control



Summer Winter



Retail Box

Fan Dimensions in Centimeters

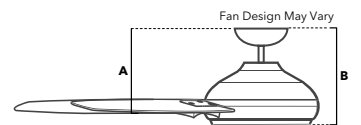

Low Profile

A. 19.2
B. 30.7

Standard

A. 21.7
B. 33.2

Angled

A. 105.6
B. 117

10.2cm downrod included (1.9cm dia.)

SKU	Size	UPC 049694	Housing Finish	Blades		Lighting Kit	Lightbulbs			Motor		Energy Information	
				Qty	Material		Qty	Base	Max. Watts	Type	Reversible	CFM High	Energy Use
50638	132cm / 52"	506382	Matte Silver / Plata Mate	3	Plastic / Plástico	No	N/A	N/A	N/A	AC	Yes / Si	5256	48W
50634		506344	Fresh White / Blanco Fresco										
50635		506351	New Bronze / Bronce Nuevo										
SKU	Tamaño	UPC 049694	Acabado	Cant.	Material	Juego de Iluminación	Cant.	Base	Watt Max.	Tipo	Reversible	Flujo de Aire	Uso Energético
				Aspas			Focos			Motor		Información Energética	

52" / 132cm Gilmour



50938

Matte White



50939

Matte Silver



AC Motor



WhisperWind® Motor



Damp Rated



Low Profile Mounting



Remote Control



Summer Winter



Retail Box



Fan Dimensions in Centimeters

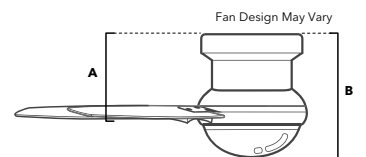

Low Profile
A. 25.1
B. 35.7

SKU	Size	EAN 0049694	Housing Finish	Blades		Lighting Kit	Lightbulbs			Motor		Energy Information	
				Qty	Material		Qty	Base	Max. Watts	Type	Reversible	CFM High	Energy Use
50938	132cm / 52"	509383	Matte White / Blanco Mate	3	Plastic / Plástico	Yes / Si	2 LED	E27	Bulbs Not Included	AC	Yes / Si	5748	44W
50939		509390	Matte Nickel / Níquel Mate										
SKU	Tamaño	EAN 0049694	Acabado	Cant.	Material	Juego de Iluminación	Cant.	Base	Watt Max.	Tipo	Reversible	Flujo de Aire	Uso Energético
					Aspas			Focos		Motor		Información Energética	

52"/ 132cm Hunter Original



50681

White



50685

Walnut
Cherry



AC Motor



Reversible
Blades



Flexible
Mounting



Damp Rated



Pull Chain



Summer
Winter



Retail Box



50/60 Hz
Dual Cycle

Fan Dimensions in Centimeters

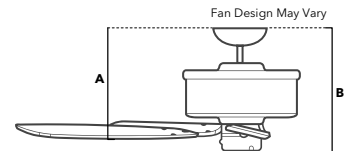

Standard
A. 30.1
B. 35.7

7.6cm downrod included (1.9cm dia.)



SKU	Size	EAN 0049694	Housing Finish	Blades		Lighting Kit	Lightbulbs			Motor		Energy Information	
				Qty	Material		Qty	Base	Max. Watts	Type	Reversible	CFM High	Energy Use
50681	132cm / 52"	506818	White / Blanco	5	Plywood / Madera Contrachapada	N/A	N/A	N/A	N/A	ACI	Yes / Si	6849	100W
50685		506856	Matte Black / Negro Mate										
SKU	Tamaño	EAN 0049694	Acabado	Cant.	Material	Juego de Iluminación	Cant.	Base	Watt Max.	Tipo	Reversible	Flujo de Aire	Uso Energético
					Aspas								Información Energética

52" / 132cm Builder Elite



51492
Premier Bronze



51493
Fresh White



AC Motor



WhisperWind® Motor



Flexible Mounting



Damp Rated



Pull Chain



Summer Winter



Retail Box



Fan Dimensions in Centimeters

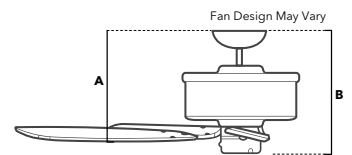

	Flush	Standard	Angled
A	25.9	28.4	112.3
B	29.6	32.1	115.9

5.1 and 7.6 downrods included (1.9 dia.)

SKU	Size	EAN 0049694	Housing Finish	Blades		Lighting Kit	Lightbulbs			Motor		Energy Information	
				Qty	Material		Qty	Base	Max. Watts	Type	Reversible	CFM High	Energy Use
51492	132cm / 52"	514929	Premier Bronze / Bronce Premier	5	Plastic / Plástico	No	N/A	N/A	N/A	AC	Yes / Si	5834	43W
51493		514936	Fresh White / Blanco Fresco										
SKU	Tamaño	EAN 0049694	Acabado	Cant.	Material	Juego de Iluminación	Cant.	Base	Watt Max.	Tipo	Reversible	Flujo de Aire	Uso Energético
					Aspas					Motor			Información Energética

54" / 137cm Bayview



24993

 Antique Dark



24996

 White



AC Motor



WhisperWind[®] Motor



Flexible Mounting



Damp Rated



Pull Chain



Summer Winter



Retail Box



50/60 Hz Dual Cycle



Fan Dimensions in Centimeters

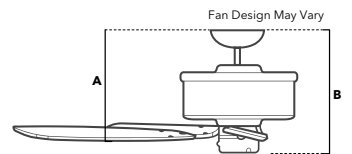

Low Profile	Standard	Angled
A. 26.5	A. 31.6	A. 117.9
B. 24.4	B. 29.5	B. 115.8



7.6cm downrod included (1.9cm dia.)

SKU	Size	EAN 0049694	Housing Finish	Blades		Lighting Kit	Lightbulbs			Motor		Energy Information	
				Qty	Material		Qty	Base	Max. Watts	Type	Reversible	CFM High	Energy Use
24993	137cm / 54"	249937	New Bronze / Bronce Nuevo	5	Plastic / Plástico	No	N/A	N/A	N/A	AC	Yes / Si	4869	41W
24996		249968	White / Blanco										
SKU	Tamaño	EAN 0049694	Acabado	Cant.	Material	Juego de Iluminación	Cant.	Base	Watt Max.	Tipo	Reversible	Flujo de Aire	Uso Energético
					Aspas				Focos		Motor		Información Energética

54" / 137cm Santorini



50648

-  Barnwood
-  Black Willow



AC Motor



WhisperWind® Motor



Flexible Mounting



Damp Rated



Reversible Blades



Pull Chain



Summer Winter



Retail Box



Fan Dimensions in Centimeters

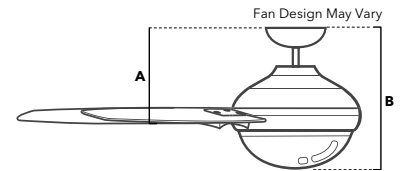

Standard
A. 24.4
B. 26.52

Standard
A. 29.5
B. 31.6

Standard
A. 115.8
B. 117.9

5.1cm and 10.2cm downrods included (1.9cm dia.)

SKU	Size	EAN	Housing Finish
50648	137cm / 54"	506481	Natural Iron / Hierro Natural
SKU	Tamaño	EAN	Acabado
		0049694	

Blades	
Qty	Material
5	Plywood / Madera Contrachapada
Cant.	Material
Aspas	

Lighting Kit	Lightbulbs		
	Qty	Base	Max. Watts
Yes / Si	2 LED	E27	Bulbs Not Included
Juego de Iluminación	Cant.	Base	Watt Max.
Focos			

Motor	
Type	Reversible
AC	Yes / Si
Tipo	Reversible
Motor	

Energy Information	
CFM High	Energy Use
4893	45W
Flujo de Aire	Uso Energético
Información Energética	

44"/ 112cm Kennicott



50935

 Fresh White



50936

 Matte Silver



50937

 Matte Black



AC Motor



WhisperWind[®] Motor



Flexible Mounting



Damp Rated



Wall Control



Summer Winter



Retail Box

Fan Dimensions in Centimeters

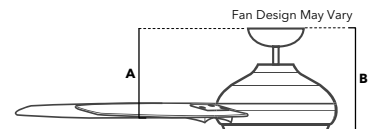

Low Profile
A. 27.6
B. 29.9

Standard
A. 30.2
B. 32.4

Angled
A. 114
B. 116.2

5.1cm and 7.6cm downrod included (1.9cm dia.)

SKU	Size	EAN 0049694	Housing Finish	Blades		Lighting Kit	Lightbulbs			Motor		Energy Information	
				Qty	Material		Qty	Base	Max. Watts	Type	Reversible	CFM High	Energy Use
50935	112cm / 44"	509352	Fresh White / Blanco Fresco	6	Plastic / Plástico	No	N/A	N/A	N/A	AC	Yes / Si	4022	40W
50936		509369	Matte Silver / Plata Mate										
50937		509376	Matte Black / Negro Mate										
SKU	Tamaño	EAN 0049694	Acabado	Cant.	Material	Juego de Iluminación	Cant.	Base	Watt Max.	Tipo	Reversible	Flujo de Aire	Uso Energético
					Aspas					Motor			Información Energética



Wet

52"/ 132cm Outdoor Elements II



24324



Teak



24326



White



AC Motor



WhisperWind® Motor



Flexible Mounting



Wet Rated



Pull Chain



Summer Winter



Retail Box

Fan Dimensions in Centimeters

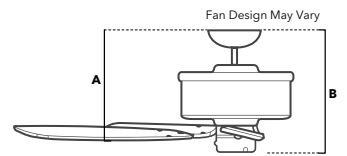

Standard
A. 31.4
B. 35.7

5.1cm downrod included (1.9cm dia.)

SKU	Size	EAN 0049694	Finish	Blades		Lighting Kit	Lightbulbs			Motor		Energy Information	
				Qty	Material		Qty	Base	Max. Watts	Type	Reversible	CFM High	Energy Use
24324	132cm / 52"	243249	Weathered Brick / Ladrilla Desgastado	5	Plastic / Plástico	No	N/A	N/A	N/A	AC	No	5370	100W
24326		243263	Snow White / Blanco Nieve										
SKU	Tamaño	EAN 0049694	Acabado	Cant.	Material	Juego de Iluminación	Cant.	Base	Watt Max.	Tipo	Reversible	Flujo de Aire	Uso Energético
				Aspas			Focos			Motor		Información Energética	

52"/ 132cm Maribel



50555



50557



AC Motor



WhisperWind® Motor



Flexible Mounting



Wet Rated



Pull Chain



Summer Winter



Retail Box

Fan Dimensions in Centimeters

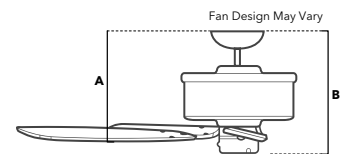

Standard
A. 28.9
B. 31.3

7.6cm downrods included (1.9cm dia.)

SKU	Size	EAN 0049694	Finish	Blades		Lighting Kit	Lightbulbs			Motor		Energy Information	
				Qty	Material		Qty	Base	Max. Watts	Type	Reversible	CFM High	Energy Use
50555	132cm / 52"	505552	New Bronze / Bronce Nuevo	5	Plastic / Plástico	No	-	-	-	AC	Yes / Si	5158	42W
50557		505576	White / Blanco										
SKU	Tamaño	EAN 0049694	Acabado	Cant.	Material	Juego de Iluminación	Cant.	Base	Watt Max.	Tipo	Reversible	Flujo de Aire	Uso Energético
					Aspas					Motor			Información Energética

54"/ 137cm Outdoor Elements II



24323



Antique Dark



24325



Natural Ruby Wicker



AC Motor



WhisperWind[®] Motor



Flexible Mounting



Wet Rated



Pull Chain



Summer Winter



Retail Box

Fan Dimensions in Centimeters

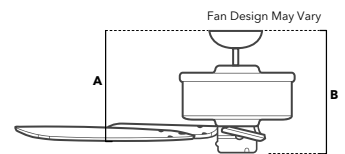

Standard
A. 31.4
B. 35.7

5.1cm downrods included (1.9cm dia.)



SKU	Size	EAN 0049694	Finish	Blades		Lighting Kit	Lightbulbs			Motor		Energy Information	
				Qty	Material		Qty	Base	Max. Watts	Type	Reversible	CFM High	Energy Use
24323	137cm / 54"	243232	New Bronze / Bronce Nuevo	5	Plastic / Plástico	No	-	-	-	AC	No	5370	100W
24325		243256	Raw Aluminum / Aluminio										
SKU	Tamaño	EAN 0049694	Acabado	Cant.	Material	Juego de Iluminación	Cant.	Base	Watt Max.	Tipo	Reversible	Flujo de Aire	Uso Energético
				Aspas			Focos			Motor		Información Energética	



WeatherMax[®]

ENGINEERED FOR THE ELEMENTS™



Tough Against Corrosion

Keeps you cool and keeps its shine. WeatherMax ceiling fans utilize tough materials that resist corrosion from water and salt air.



Wet Rated

Come mist, shower or thunderstorm, a WeatherMax ceiling fan will stand strong against water damage to avoid malfunction or blade droop.



Maintains Shape

Blades stay straight and will not droop like other fans. Our blades are always ready to create an optimal, cooling breeze when you need it.



THE BEST OUTDOOR CEILING FANS IN THE INDUSTRY

52"/ 132cm Trimaran



50943

 Brushed Cocoa



50942

 Fresh White



AC Motor



WhisperWind® Motor



Flexible Mounting



Droop Free Blades



Wall Control



Summer Winter



Retail Box

Fan Dimensions in Centimeters

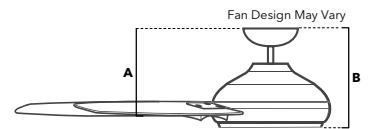

Standard
A. 22.9
B. 26.8

Standard
A. 28
B. 31.9

Standard
A. 94
B. 123.3

5.1cm and 7.6cm downrod included (1.9cm dia.)

SKU	Size	EAN 0049694	Finish
50942	132cm / 52"	509420	Fresh White / Blanco Fresco
50943		509437	Premier Bronze / Bronce Primero
SKU	Tamaño	EAN 0049694	Acabado

Blades		Lighting Kit	Lightbulbs		
Qty	Material		Qty	Base	Max. Watts
3	Plastic / Plástico	No	N/A	N/A	N/A
Cant.	Material	Juego de Iluminación	Cant.	Base	Watt Max.
Aspas			Focos		

Motor		Energy Information	
Type	Reversible	CFM High	Energy Use
AC	Yes / Si	5383	44W
Tipo	Reversible	Flujo de Aire	Uso Energético
Motor		Información Energética	

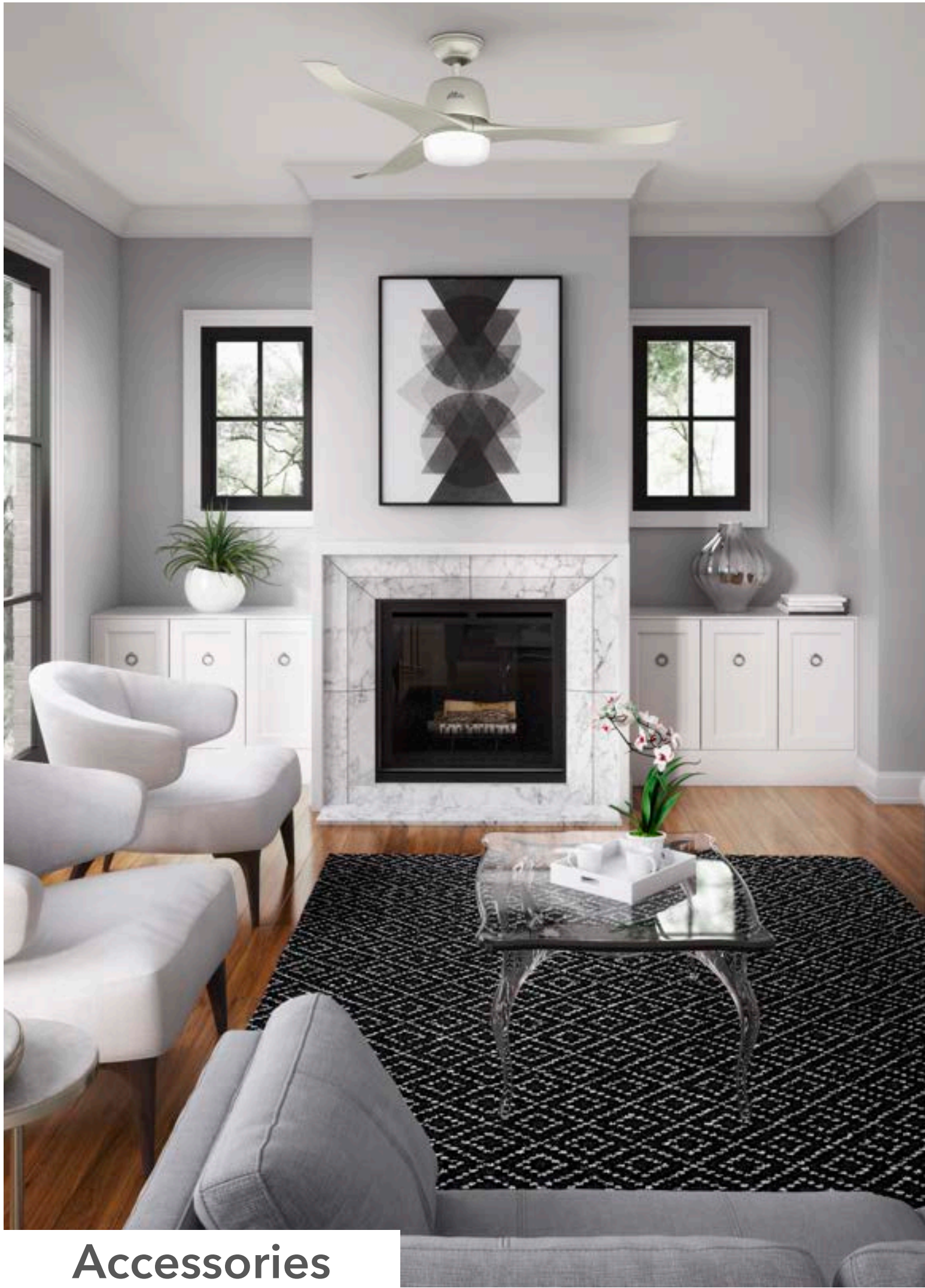

Accessories

HUNTER LIGHT ACCESSORIES



50900
Flight Light Kit
EAN: 0049694509000



24301
Tribeca Light Kit,
Brushed Nickel
EAN: 0049694243010



24304
Tribeca Light Kit,
Graphite
EAN: 0049694243041



24307
Tribeca Light Kit,
White
EAN: 0049694243072



24310
3 Light Flush Mount,
Antique Brass
EAN: 0049694243102



24312
3 Light Flush Mount,
Bright Brass
EAN: 0049694243126



24316
3 Light Flush Mount,
White
EAN: 0049694243164



24318
3 Light Flush Mount,
Brushed Nickel
EAN: 0049694243188



24319
3 Light Flush Mount,
New Bronze
EAN: 0049694243195



24122
Scavo Bowl w/
BC,SB,WH,BB Finials
EAN: 0049694241221



24125
Amber Bowl w/
BC,SB,WH,BB Finials
EAN: 0049694241252



24126
Frosted Opal Bowl
Light w/ BC,SB,WH,
BB Finials
EAN: 0049694241269



24127
Swirled Marble Bowl
w/ BC,SB,WH,BB
Finials
EAN: 0049694241276



22515
8" Opal Glass
Schoolhouse Globe
EAN: 0049694225153



22555
10" Opal Glass
Schoolhouse Globe
EAN: 0049694225559



22565
Contemporary
Schoolhouse Globe
EAN: 0049694225658



24335
Outdoor Light Kit,
New Bronze
EAN: 0049694243355



24336
Outdoor Light Kit,
White
EAN: 0049694243362



24337
Outdoor Light Kit,
Raw Aluminum
EAN: 0049694243379



50910
Angra Outdoor Light
Kit, New Bronze
EAN: 0049694509109



50911
Angra Outdoor
Light Kit, White
EAN: 0049694509116



24432
Globe Adapter, White
(12 per carton)
EAN: 0049694244321



24434
Globe Adapter, Bright
Brass (12 per carton)
EAN: 0049694244345



24435
Globe Adapter,
Brushed Chrome (12
per carton)
EAN: 0049694244352

HUNTER CONTROLS



99390
3-Speed and light
dimming remote
(AAA Batteries)
EAN: 0049694993908



24757
240v 3-Speed Wall
Control (w/Light)
EAN: 0049694247575
Includes 2 wall plates



24758
240v 3-Speed Wall
Control (No Light)
EAN: 0049694247582
Includes 2 wall plates





K598201000
Dual Cycle Reciever







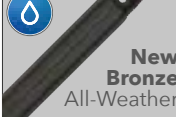

K834001000
Universal Multi-Fan
Wall Control







HUNTER ORIGINAL® DOWNRODS

	12"	18"	24"	36"	48"	60"	72"
 Black Indoor	26302 0049694263025	26219 0049694262196	26227 0049694262271	26228 0049694262288	26229 0049694262295	23194 0049694231949	23064 0049694230645
 Chestnut Brown Indoor	22711 0049694227119	22721 0049694227218	26331 0049694263315	26341 0049694263414	26351 0049694263513	x	23065 0049694230652
 White Indoor	22717 0049694227171	22727 0049694227270	26317 0049694263179	26327 0049694263278	26337 0049694263377	23197 0049694231970	23067 0049694230676
 New Bronze All-Weather	25998 0049694259981	25999 0049694259998	26007 0049694260079	26008 0049694260086	x	x	x



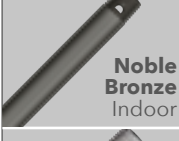

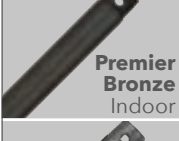
HUNTER DOWNRODS

	12"	18"	24"	36"	48"	60"	72"
 Antique Brass Indoor	22719 0049694227195	22729 0049694227294	26319 0049694263193	26329 0049694263292	26339 0049694263391	23190 0049694231901	23060 0049694230607
 Black Indoor	25144 0049694251442	25145 0049694251459	25146 0049694251466	25147 0049694251473	25148 0049694251480	25149 0049694251497	25150 0049694251503
 Bronze Patina Indoor	28206 0049694282064	28207 0049694282071	28208 0049694282088	28209 0049694282095	28210 0049694282101	x	x
 Brushed Nickel Indoor	26019 0049694260192	26020 0049694260208	26021 0049694260215	26022 0049694260222	26023 0049694260239	26024 0049694260246	26025 0049694260253
 Cottage White Indoor	99200 0049694992000	99201 0049694992017	99202 0049694992024	99203 0049694992031	99204 0049694992048	99205 0049694992055	99206 0049694992062
 Fresh White Indoor	99700 0049694997005	99701 0049694997012	99702 0049694997029	99703 0049694997036	99704 0049694997043	99705 0049694997050	99706 0049694997067
 Hunter Bright Brass Finish Indoor	22713 0049694227133	22723 0049694227232	26313 0049694263131	26323 0049694263230	26333 0049694263339	23192 0049694231925	23062 0049694230621

HUNTER DOWNRODS

	12"	18"	24"	36"	48"	60"	72"
 Polished Brass Indoor	25176 0049694251763	x	25178 0049694251787	x	x	x	x
 Matte Silver Indoor	99301 0049694993014	99302 0049694993021	99303 0049694993038	99304 0049694993045	99305 0049694993052	99306 0049694993069	99307 0049694993076
 New Bronze Indoor	26041 0049694260413	26042 0049694260420	26043 0049694260437	26044 0049694260444	26045 0049694260451	26046 0049694260468	26047 0049694260475
 Noble Bronze Indoor	99294 0049694992949	99295 0049694992956	99296 0049694992963	99297 0049694992970	99298 0049694992987	99299 0049694992994	99300 0049694993007
 Polished Nickel Indoor	99280 0049694992802	99281 0049694992819	99282 0049694992826	99283 0049694992833	99284 0049694992840	99285 0049694992857	99286 0049694992864
 Premier Bronze Indoor	99708 0049694997081	99709 0049694997098	99710 0049694997104	99711 0049694997111	99712 0049694997128	99713 0049694997135	99714 0049694997142
 Satin Nickel Indoor	99271 0049694992710	99272 0049694992727	99273 0049694992734	99274 0049694992741	99275 0049694992758	x	x

WEATHERMAX® DOWNRODS

	12"	18"	24"	36"	48"
 Matte Silver	99730 0049694997302	99731 0049694997319	99732 0049694997326	99733 0049694997333	99734 0049694997340
 Matte Black	99738 0049694997388	99739 0049694997395	99740 0049694997401	99741 0049694997418	99742 0049694997425
 Fresh White	99746 0049694997463	99747 0049694997470	99748 0049694997487	99749 0049694997494	99750 0049694997500
 Noble Bronze	99755 0049694997555	99756 0049694997562	99757 0049694997579	99758 0049694997586	99759 0049694997593

Hunter Downrods
are 3/4" diameter

INDEX BY SKU

Brand	SKU	Family Name	Inches	cm	Page #
Hunter	24034	Seville II	44	112	29
Hunter	24037	Seville II	44	112	29
Hunter	24038	Seville II	44	112	29
Hunter	24039	Seville II	44	112	29
Hunter	24170	Bayport	42	107	27
Hunter	24174	Bayport	42	107	27
Hunter	24179	Bayport	42	107	27
Hunter	24241	Carera	52	132	14
Hunter	24246	Carera	52	132	14
Hunter	24323	Outdoor Elements II	54	137	48
Hunter	24324	Outdoor Elements II	52	132	46
Hunter	24325	Outdoor Elements II	54	137	48
Hunter	24326	Outdoor Elements II	52	132	46
Hunter	24372	Low Profile III	44/52	112/132	30
Hunter	24377	Low Profile III	44/52	112/132	30
Hunter	24457	Caribbean Breeze	54	137	35
Hunter	24520	Savoy	52	132	34
Hunter	24521	Savoy	52	132	34
Hunter	24524	Savoy	52	132	34
Hunter	24525	Savoy	52	132	34
Hunter	24526	Savoy	52	132	34
Hunter	24542	Industrie II	52	132	13
Hunter	24545	Industrie II	52	132	13
Hunter	24547	Industrie II	52	132	13
Hunter	24902	Beacon Hill	42	107	28
Hunter	24904	Beacon Hill	42	107	28
Hunter	24905	Beacon Hill	42	107	28
Hunter	24993	Bayview	54	137	42
Hunter	24996	Bayview	54	137	42
Hunter	50423	Loki	52	132	21
Hunter	50424	Loki	52	132	21
Hunter	50425	Loki	52	132	21
Hunter	50555	Maribel	52	132	47
Hunter	50557	Maribel	52	132	47
Hunter	50560	Builder Plus	52	132	33
Hunter	50561	Builder Plus	52	132	33
Hunter	50562	Builder Plus	52	132	33
Hunter	50565	Builder Elite	52	132	31
Hunter	50566	Builder Elite	52	132	31
Hunter	50567	Builder Elite	52	132	31
Hunter	50570	Builder Deluxe	52	132	32
Hunter	50571	Builder Deluxe	52	132	32
Hunter	50572	Builder Deluxe	52	132	32
Hunter	50610	Kohala Bay	48	122	11

Brand	SKU	Family Name	Inches	cm	Page #
Hunter	50612	Contempo	52	132	25
Hunter	50613	Contempo	52	132	25
Hunter	50616	Nova	42	107	9
Hunter	50617	Nova	42	107	9
Hunter	50618	Central Park	42	107	17
Hunter	50619	Central Park	42	107	17
Hunter	50621	Galileo	48	122	10
Hunter	50622	Protos	52	132	37
Hunter	50623	Protos	52	132	37
Hunter	50624	Protos	52	132	37
Hunter	50625	Harmony	54	137	15
Hunter	50626	Harmony	54	137	15
Hunter	50628	Dante	44	112	18
Hunter	50629	Dante	44	112	18
Hunter	50630	Flight	52	132	12
Hunter	50634	Cabo Frio	52	132	38
Hunter	50635	Cabo Frio	52	132	38
Hunter	50638	Cabo Frio	52	132	38
Hunter	50640	Stile	46	117	22
Hunter	50641	Stile	46	117	22
Hunter	50643	Finley	36	91	8
Hunter	50644	Finley	36	91	8
Hunter	50646	Arcot	46	117	23
Hunter	50647	Arcot	46	117	23
Hunter	50648	Santorini	54	137	43
Hunter	50650	Mercado	50	127	19
Hunter	50652	Claudette	52	132	24
Hunter	50655	Beck	42	107	16
Hunter	50665	Sonic	52	132	20
Hunter	50666	Sonic	52	132	20
Hunter	50681	Hunter Original®	52	132	40
Hunter	50685	Hunter Original®	52	132	40
Hunter	50935	Kennicott	44	112	44
Hunter	50936	Kennicott	44	112	44
Hunter	50937	Kennicott	44	112	44
Hunter	50938	Gilmour	52	132	39
Hunter	50939	Gilmour	52	132	39
Hunter	50942	Trimaran	52	132	52
Hunter	50943	Trimaran	52	132	52
Hunter	50964	Harmony	54	137	15
Hunter	51220	Protos	52	132	37
Hunter	51492	Builder Elite OD	52	132	41
Hunter	51493	Builder Elite OD	52	132	41

PACKAGING REFERENCES



Retail Box



TERMS AND CONDITIONS

For FOB Asia orders, Minimum Order Quantity (MOQ) for Ceiling Fans is 300 pieces, for Remotes 500 pieces, and for Accessories 300 pieces. All products are available to ship from Byhalia, Mississippi, USA. All products are third party tested and approved to IEC electrical standards.

DAMAGED GOODS: All merchandise is packed carefully to avoid damage in transit. Responsibility is assumed by purchaser upon delivery by us to the carrier or freight consolidator. If shortages or damage occurs in transit, purchaser must file claim with the carrier or freight consolidator.

LEAD TIME: Standard FOB lead time is 90 days from confirmation of purchase order.

FREIGHT ALLOWANCE: Shipments from Byhalia-LCL- Ex-works warehouse (Byhalia) with freight pre-paid to one US continental destination. FCL- Ex-works warehouse (Byhalia). Shipments from Asia-LCL- Ex-works Factory. FCL- FOB Origin Port.



Hunter[®]

©2022 Hunter Fan Company
7130 Goodlett Farms PKWY, Suite 400
Memphis, TN 38016